

COGNEX

World's First AI-Powered 3D Vision System

IN-SIGHT L38 SERIES



In-Sight L38 Series

AI-powered 3D inspection system delivers fast deployment, ease of use, and reliable performance

The In-Sight® L38 is a next-generation 3D vision system that allows manufacturers to perform highly reliable inspections. Using a combination of embedded AI, powerful optics, and industry-proven vision technology, the system captures detailed 3D images and analyzes depth information to detect subtle features and measure them against pass/fail thresholds. In-Sight L38 solves a range of inspection, measurement, and guidance applications with precision to ensure every product meets your quality standards, down to the smallest detail.



Maximize operational efficiency with fast, easy deployment

- Point-and-click training interface guides users step-by-step through setup
- Easy-to-use vision tools and example-based training simplify the development of complex applications
- Embedded AI solves applications in minutes, requiring only 5 to 10 labeled images for consistent results

➔ PAGE 4

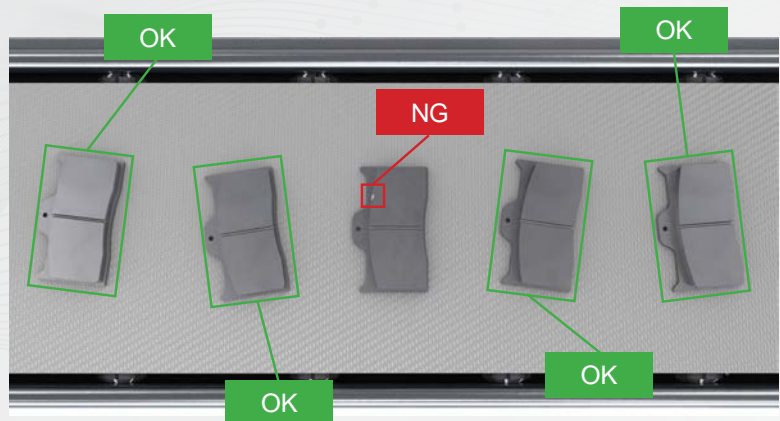
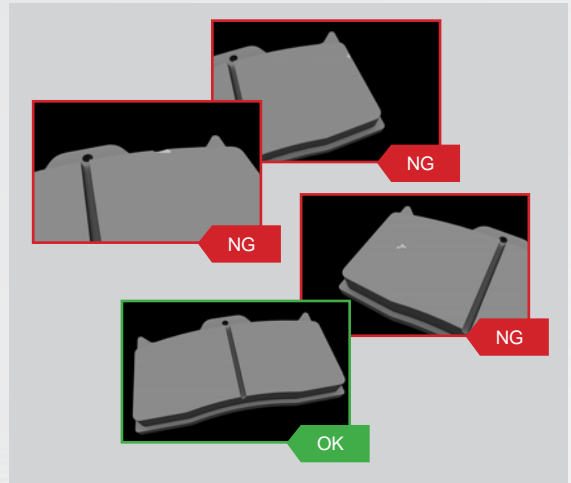
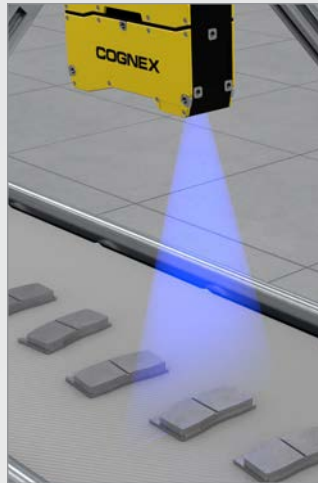

Improve inspection reliability and throughput with AI and advanced imaging

- Advanced AI detects subtle, variable features and delivers precise 3D measurements to gauge the severity of anomalies

➔ PAGE 4

- Patented, speckle-free laser reduces optical noise to generate high-contrast images
- Unique, high-powered laser line quickly scans parts to keep up with line speeds

➔ PAGE 10

Advanced AI detection

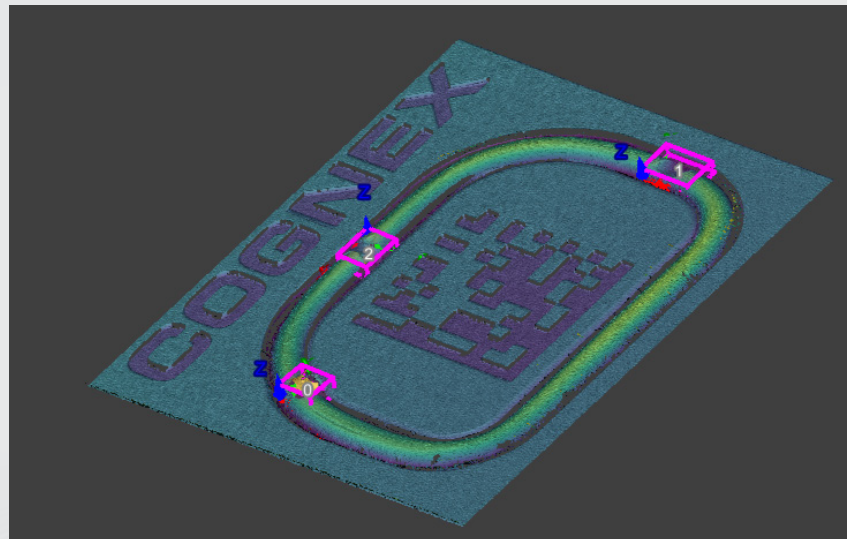

Patented, speckle-free laser

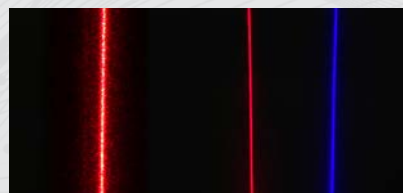

High-powered laser



Scale your automation with a flexible vision platform

- Universal software platform supports all In-Sight products for easy expansion
- Flexible development options allow users to start with image-based training and seamlessly transition to spreadsheet programming
- Full suite of 2D and 3D tools delivers simplicity and speed for standard applications and advanced capabilities for complex tasks

➔ PAGE 7

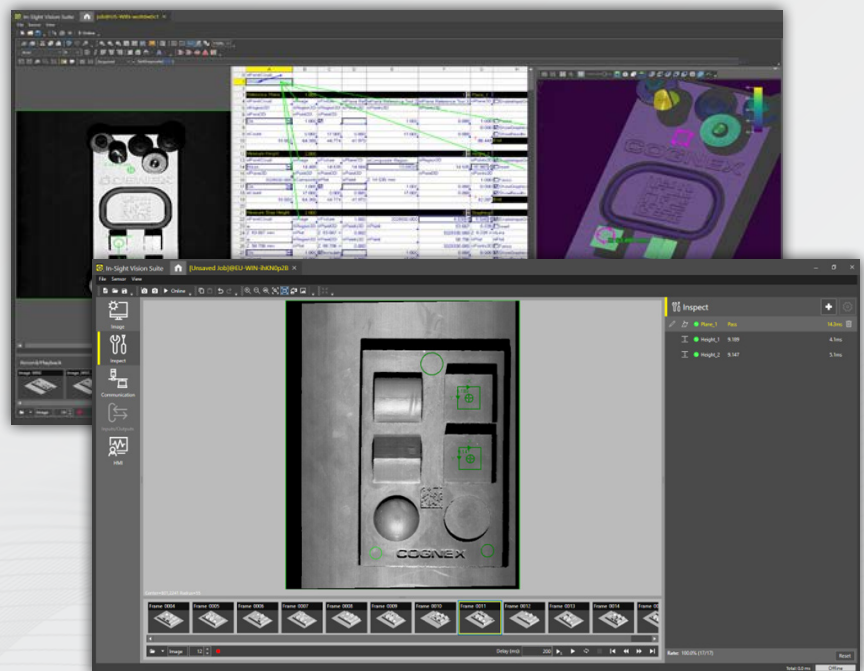

See more with the combined power of 3D and AI

Integrating AI, 2D, and 3D technology in a single vision system, the In-Sight L38 addresses different inspection, measurement, and gauging applications. AI tools handle part variation, allowing users to detect subtle, variable, and even undefined features, while rule-based algorithms deliver reliable 3D measurements to assess the severity of anomalies. The tools can be used individually for simple jobs or combined to automate more challenging tasks.



AI tools

The In-Sight L38 uses AI-powered edge learning tools to process images directly on device and deliver accurate results in real time. The system features 2D AI tools that process 2D images, as well as 3D AI tools that process 3D point cloud images. With example-based training and no experience needed, these tools simplify the development of both 3D and 2D applications for fast implementation.

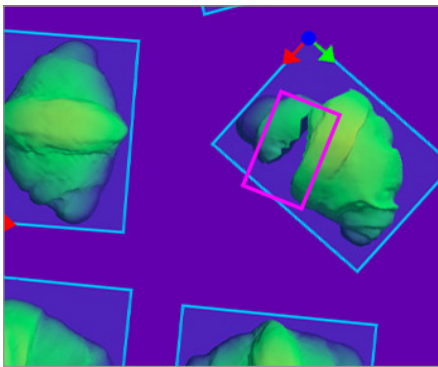

ViDi™ EL Segment (3D/2D)

Locate and extract defects, regions, and objects from complex parts and backgrounds in real-world units.

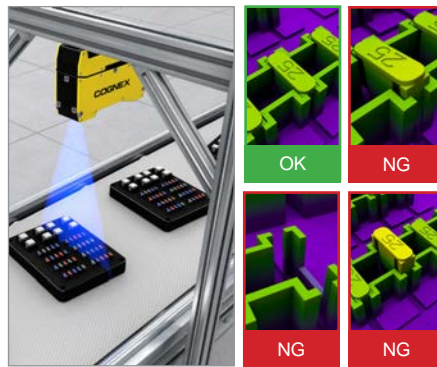

ViDi EL Classify (3D/2D)

Detect and sort parts based on multiple features or characteristics.

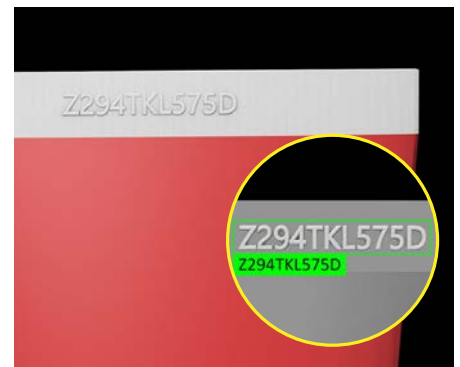

ViDi EL Read (2D)

Read characters on reflective, low-contrast, and non-flat surfaces, including multi-line text.



Rule-based vision tools

In-Sight L38 is also equipped with a library of industry-proven traditional vision tools that allow users to measure distance and blobs, count pixels, and patterns, read codes, guide robots, perform math and logic, and more.



3D BeadInspect Tool

In-Sight L38 comes equipped with the 3D rule-based BeadInspect tool, purpose-built to inspect gaskets and glue beads. The tool allows users to gauge width and height along the entire length of a gasket or glue bead to detect defects, measure variances against thresholds, and deliver results in three dimensions.

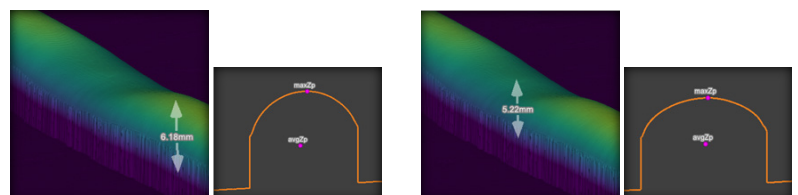

NEW 3D ViDi EL Segment Tool

Advanced applications, such as those involving the detection and measurement of difficult-to-see defects, often require the use of multiple vision tools. In-Sight L38 easily solves these applications, with just one tool – 3D ViDi EL Segment. This tool detects challenging defects, gauges variances in three dimensions, and delivers results in real-world units to streamline workflows and deliver high reliability.

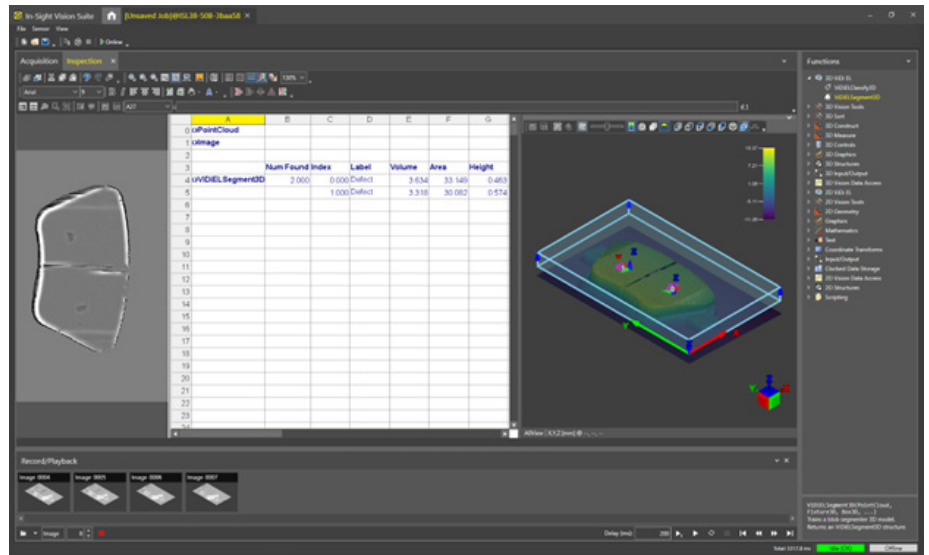

Find 3D defects with easy 2D training

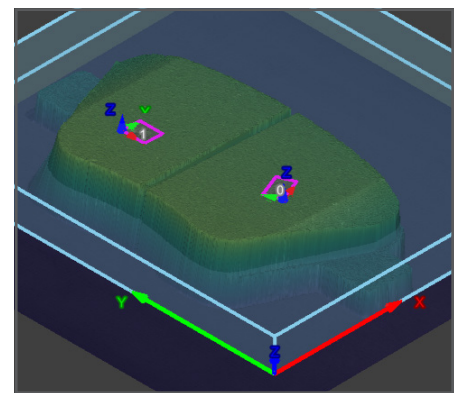
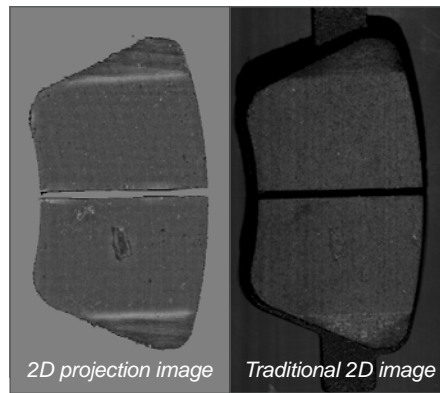
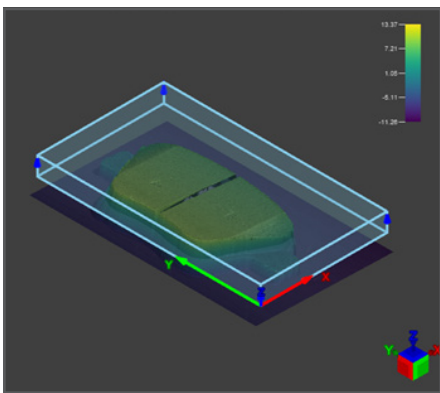

Step 1: Set region of interest on a 3D point cloud image

- Partial or full regions can be selected
- Accepts fixtures from 2D or 3D tools but can be set up without fixturing

Step 2: Train defects on 2D projection image

- Unique projection images combine 3D information into an easy-to-label 2D image and reveal features not easily visible with traditional 2D imaging.
- 7x projection image modes available for training
- Auto-tune selects the best projection modes

Step 3: Detect defects in the point cloud image and measure them in three dimensions

- Multiple defect classes can be defined (ex. scratch, dent, etc.)
- Outputs include volume, area, and height of defects in real-world units

Application Examples

Food & beverage: Locate parts in variable positions and close proximity

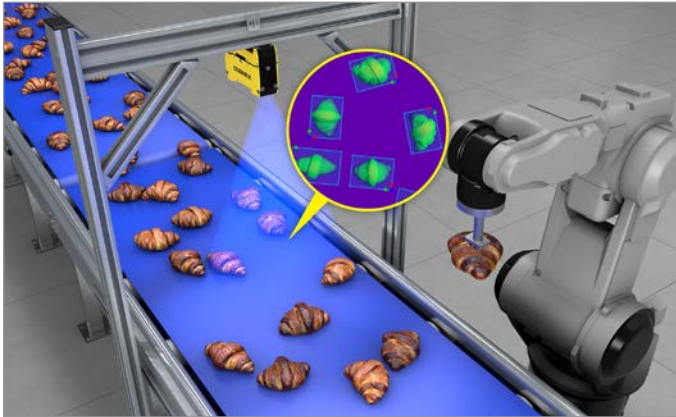

Consumer products: Read imprinted text, even with minimal contrast

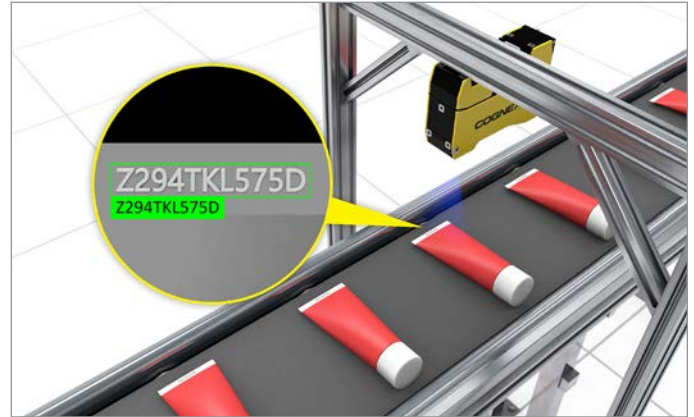

Automotive: Find subtle defects on the surfaces of parts

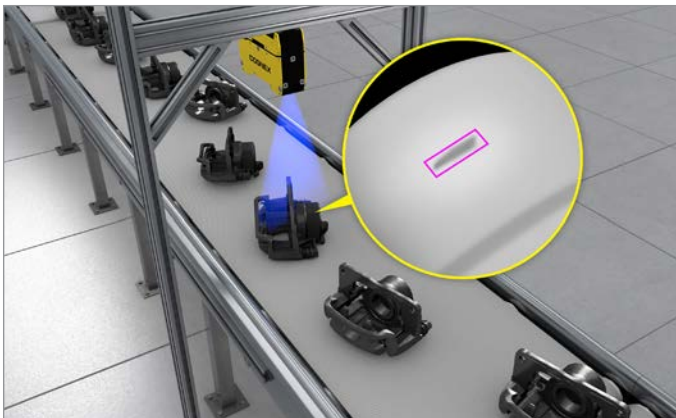

Automotive: Inspect for and classify variable defects

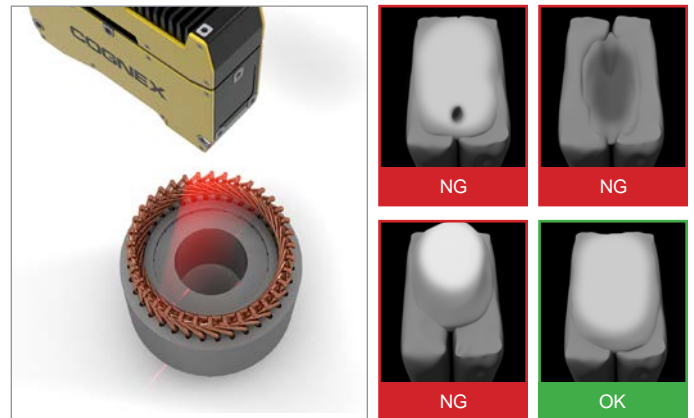

Packaging: Measure glue on boxes to ensure consistent application

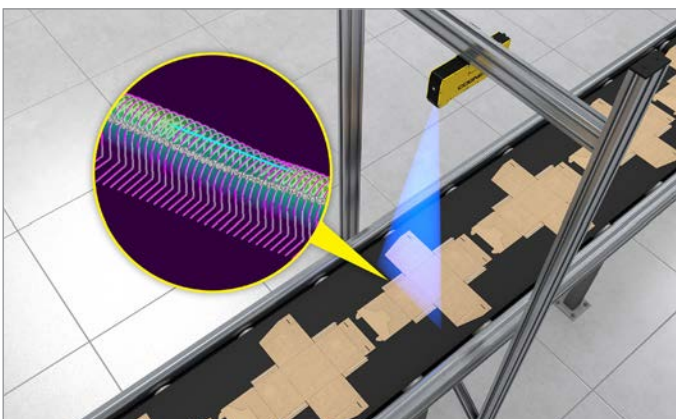

Automotive: Read text on low-contrast backgrounds

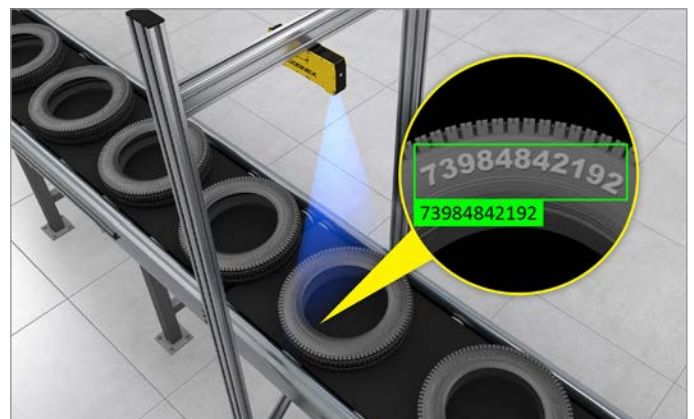

Common software platform offers flexible development options

In-Sight Vision Suite software is common across all In-Sight products and includes two programming environments — spreadsheet and EasyBuilder®. Start with EasyBuilder, a wizard-like training interface designed for simplicity, and transition to more advanced, spreadsheet programming. In-Sight Vision Suite uniquely integrates these two approaches, providing a seamless experience within the same platform that allows users to efficiently scale their automation.

Spreadsheet facilitates deployment of advanced applications

The spreadsheet interface is ideal for building complex and highly customized applications. Robust in design, this development environment gives users the ability to make critical adjustments to job parameters and quickly adapt applications to address new requirements.

Powerful spreadsheet interface allows users to solve complex applications

	A	B	C	D	E	F	G	H
0	aPointCloud							
1	aImage							
2								
3	Reference Plane	1.000				1	Plane_1	
4	aPointCloud	aImage	aFixture	aPlane Ref	aPlane Reference Tool 2	aPlane Reference Tool 3	aPlane3D	<input type="checkbox"/> EnableInput
5	aRegion3D	aRegion3D	aRegion3D	aPoints3D	aPoints3D	aPoints3D		
6	aPoint3D	aPoint3D	aPoint3D					
7	On	1.000	<input checked="" type="checkbox"/>		1.000	0.000	1.000	<input type="checkbox"/> Focus
8							0.000	<input checked="" type="checkbox"/> ShowGraph
9	aCount	0.000	17.000	0.000	17.000	0.000		<input type="checkbox"/> ShowResult
10		19.583	64.356	44.774	41.970		88.449	End
11								
12	Measure Height	2.000				2	Height_1	
13	aPointCloud	aImage	aFixture	aPlane3D	aComposite Region	aRegion3D	aPoints3D	<input checked="" type="checkbox"/> EnableInput
14	Mean	14.488	14.535	14.584	13.080	14.535	15.987	<input type="checkbox"/> Invert
15	aPlane3D	aPoint3D	aPoint3D	aPoint3D	aPoint3D	aPoint3D	aPoint3D	
16		3329330.000	aComposite	aPlot	aPoint	Z: 14.535 mm		<input type="checkbox"/> Focus
17	On	1.000	<input checked="" type="checkbox"/>		1.000	0.000	0.000	<input checked="" type="checkbox"/> ShowGraph
18	aCount	17.000	0.000	0.000	17.000	0.000		<input checked="" type="checkbox"/> ShowResult
19		19.583	64.356	44.774	41.970		42.097	End

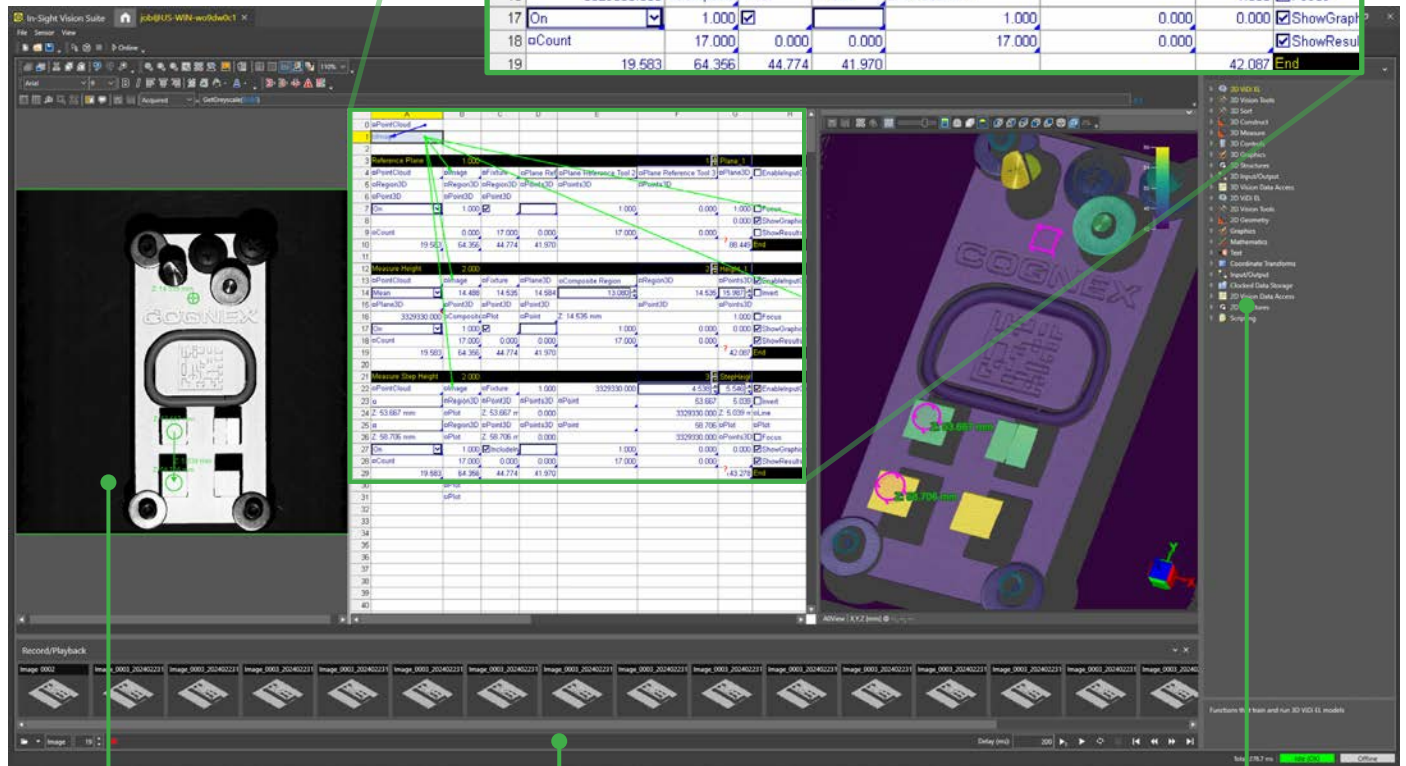

Image playback for easy review and recall

Complete I/O and communications function set streamlines factory integration

Full suite of AI- and rule-based vision tools

EasyBuilder development environment simplifies setup

With point-and-click training, the EasyBuilder interface within In-Sight Vision Suite is ideal for setting up simple or common jobs. The intuitive process guides users step-by-step through setup—from image capture to the final result and beyond—allowing both new and experienced developers to configure reliable vision applications.

Easy **step-by-step** application setup

Image-centric **point-and-click** functionality allows users to quickly train tools

Capture live images or **upload** existing libraries

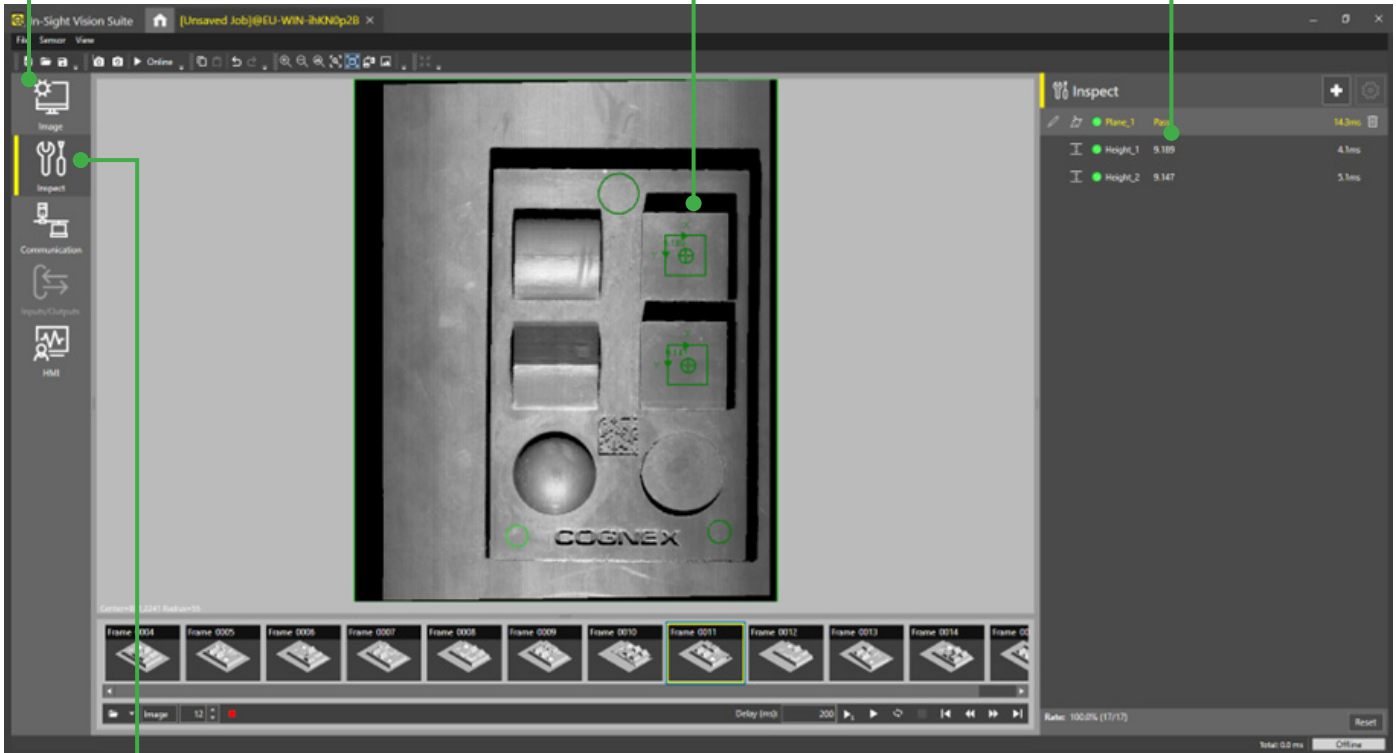

Entire set of traditional rule-based vision tools and **innovative edge learning** tools

Fully embedded vision system offers complete solution

The In-Sight L38 includes the entire library of Cognex 2D, 3D, and AI vision tools, powerful optics, and other convenient features to provide a complete solution for factory automation.



In-Sight L38-500

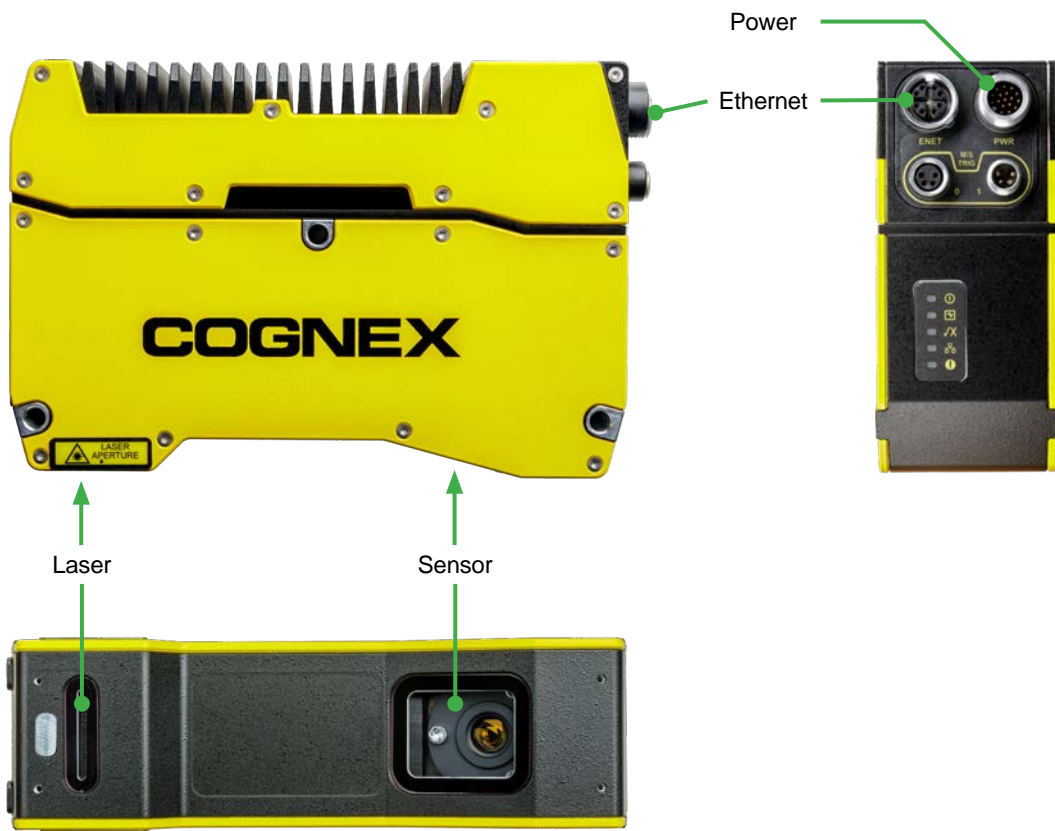

In-Sight L38

Powerful, integrated lighting technology optimizes image formation

In-Sight L38 offers advanced optics on-device, no external lighting required, to simplify deployment. Speckle-free and high-powered laser lines maximize contrast, even against challenging surfaces, and generate high-resolution images to improve the accuracy of automated inspections.

Patented, speckle-free laser

- Minimizes speckle and glare, common problems for 3D laser systems
- Captures higher resolution images than traditional laser displacement sensors
- Delivers the most consistent laser line in the industry for more reliable scanning
- Available on the following models: ISL38-33, ISL38-50, ISL38-100, and ISL38-300.

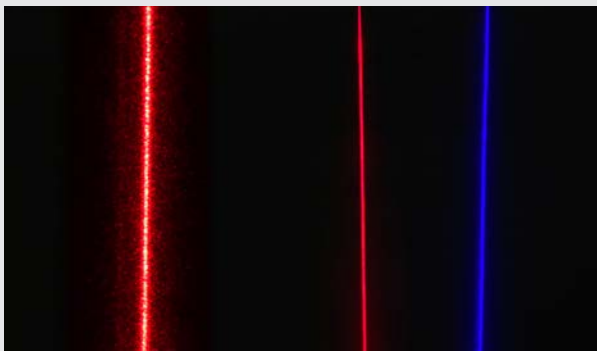

Conventional laser line (left) and speckle-free laser line red and blue (right)

High-powered laser

- Delivers fast acquisition rates to support high line speeds
- Meets Class 2 safety standards, eliminating the need for expensive enclosures and allowing users to make adjustments without stopping the line
- Offers 5X more light than conventional lasers to enable image acquisition at greater distances
- Available on the following model: ISL38-500.

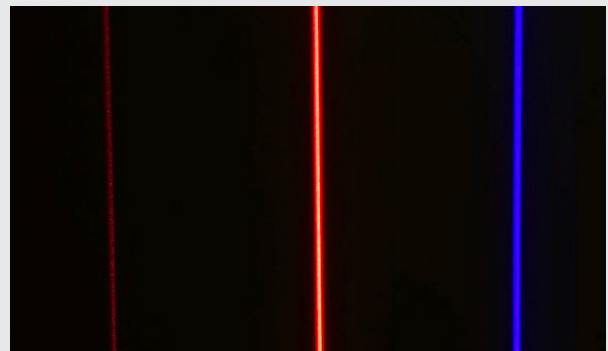

Conventional laser line (left) and high-powered laser line red and blue (right)

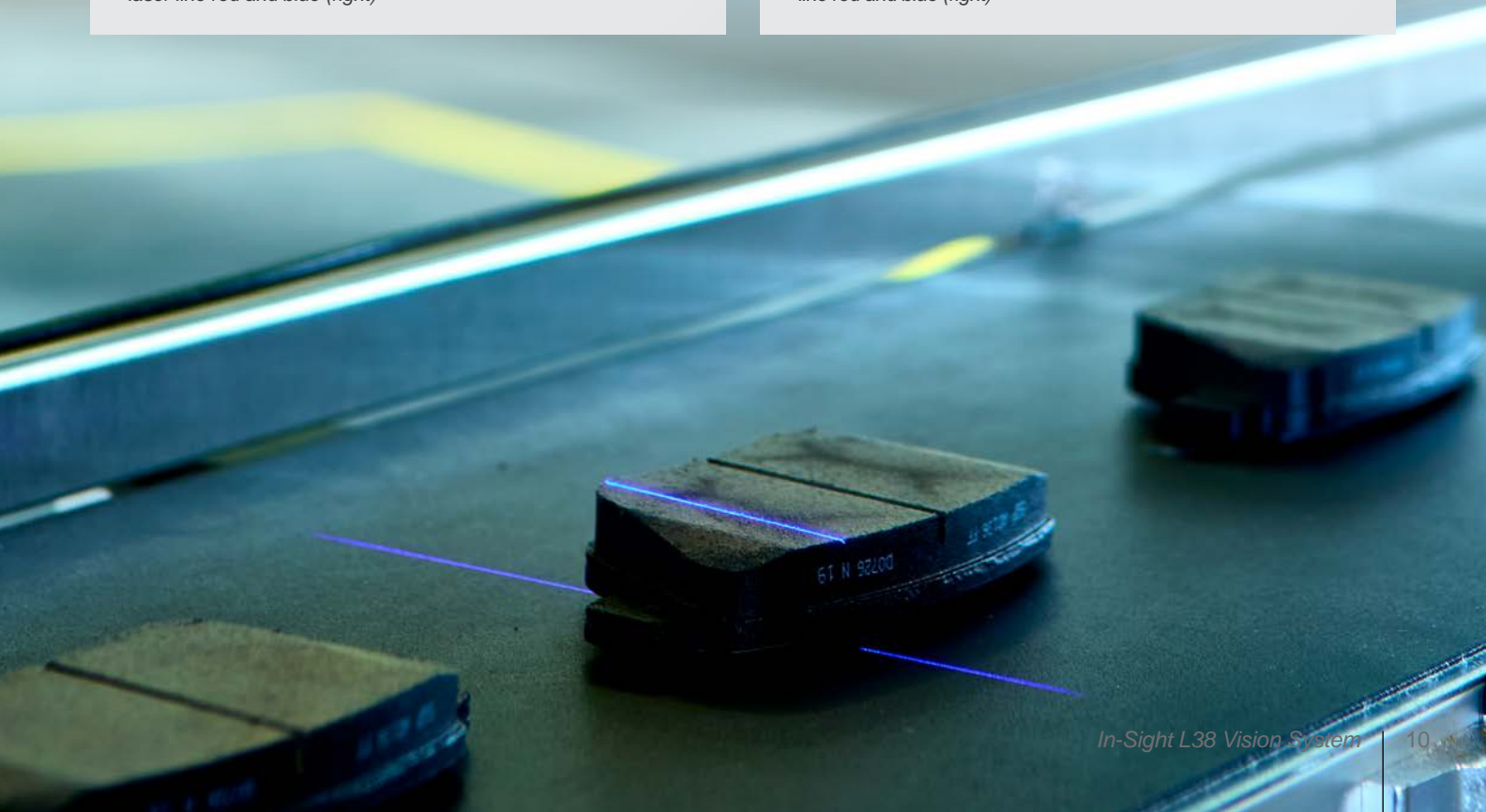

IN-SIGHT L38 SERIES SPECIFICATIONS

Model		ISL38-33	ISL38-50	ISL38-100	ISL38-300	ISL38-500	
Measurement range	Clearance distance	93.00	92.00	130.00	180.00	600	
	Z-axis (height)	Measurement range (mm)	44.00	106.00	235.00	745.00	1100
		Near field of view (mm)	33.00	55.00	75.00	95.00	405
	X-axis (width)	Middle field of view (mm)	36.00	73.00	128.00	278.00	744
		Far field of view (mm)	39.00	90.00	180.00	460.00	1082
Laser (light source, Blue or Red)	Wavelength (nm)	450 (blue)	450 (blue), 640 (red)			450 (blue), 640 (red)	
	Laser class	2M					
	Output power (mW)	45	45 (blue), 48 (red)			300 (blue), 280 (red)	
Spot size (middle field of view) μm		72	110 (blue), 140 (red)	181 (blue), 235 (red)	240 (blue), 350 (red)	360 (blue), 480 (red)	
Sensor	Data points/profile	1920	1920	1920	1920	1920	
	X resolution	Top (μm)	17.2	28.6	39.1	49.5	213
		Bottom (μm)	20.3	46.9	93.8	239.6	574
	Z resolution	Top (μm)	1.7	2.5	4.4	6.9	42
		Bottom (μm)	2.7	6.9	25.9	147.5	302
	Z repeatability ^{*1}	Mid (μm)	0.5	0.5	1	2	10
	Z linearity (% of full scale [F.S.]) ^{*2}		± 0.06	± 0.06	± 0.04	± 0.05	± 0.1
Temperature characteristics (% of F.S./ $^{\circ}\text{C}$)		0.01					
Environmental resistance	Housing protection	IP65					
	Operation temperature ($^{\circ}\text{C}$) ^{*3}	0 $^{\circ}\text{C}$ —35 $^{\circ}\text{C}$ without heat sink, 0 $^{\circ}\text{C}$ —45 $^{\circ}\text{C}$ with heat sink					
	Storage temperature ($^{\circ}\text{C}$)	-20 $^{\circ}\text{C}$ to 70 $^{\circ}\text{C}$					
	Relative humidity	<80% (no condensation)					
	Vibration (Hz)	10 to 57, double amplitude 1.5 mm X, Y, Z, 3 hours in each direction					
	Shock (G)	15 / 6 msec					
Scan rate		Up to 7 kHz (after reducing the measurement range size) (up to 10 kHz ^{*4})					
Housing material		Aluminum					
Weight (Kg)		0.94				1.28	
Dimensions (mm)		150.5 x 101 x 45				200.5 x 101 x 45	
Job/program memory		32GB					
Image processing memory (RAM)		8GB					
Power supply requirements		24VDC $\pm 10\%$, 750mA minimum					
Inputs		Trigger, differential/single ended encoder, laser interlock					
Trigger	Input voltage limits	Trig+ – Trig - = - 24VDC to +24VDC					
	Input ON	> 10 VDC (> 6 mA)					
	Input OFF	< 2 VDC (< 1.5 mA)					
Encoder specifications	Differential	A+/B+: 5—24V (1.0 MHz max) A-/B-: Inverted (A+/B+)					
	Single ended	A+/B+: 12—24V (1.0 MHz max) A-/B-: VDC = 1/2 (A+/B+)					
Interface		Gigabit Ethernet interface; Integrated link and traffic LEDs; Standard M12-8 X-Coded female connector					
Communication protocols		TCP/IP, PROFINET, EtherNet/IP, SLMP, ModbusTCP, (S)FTP, RS-232C					

*1 Z Repeatability is measured an average of 100 times over a point cloud using a 4x4 mm area, at the middle of the Measurement Range.

*2 Z Linearity is the max deviation of 250 position measurements on the Measurement Range, where a measurement is the average of 2 profiles using the standard Cognex target.

*3 Mounted to a 400 mm aluminum bar on top of the camera.

*4 When enable binning and the FOV is windowed down.





Calibration at 21 $^{\circ}\text{C}$ ambient temperature



Product IDs and descriptions



IN-SIGHT L38 SERIES			
Product ID	Points/Profile	Laser Color	Toolset
ISL38-33B-SA	2K	Blue	EB/SS ¹ , all tools
ISL38-33B-SR	2K	Blue	EB/SS, rules based tools only
ISL38-50B-SA	2K	Blue	EB/SS, all tools
ISL38-50B-SR	2K	Blue	EB/SS, rules based tools only
ISL38-50R-SA	2K	Red	EB/SS, all tools
ISL38-50R-SR	2K	Red	EB/SS, rules based tools only
ISL38-100B-SA	2K	Blue	EB/SS, all tools
ISL38-100B-SR	2K	Blue	EB/SS, rules based tools only
ISL38-100R-SA	2K	Red	EB/SS, all tools
ISL38-100R-SR	2K	Red	EB/SS, rules based tools only
ISL38-300B-SA	2K	Blue	EB/SS, all tools
ISL38-300B-SR	2K	Blue	EB/SS, rules based tools only
ISL38-300R-SA	2K	Red	EB/SS, all tools
ISL38-300R-SR	2K	Red	EB/SS, rules based tools only
ISL38-500B-SA	2K	Blue	EB/SS, all tools
ISL38-500B-SR	2K	Blue	EB/SS, rules based tools only
ISL38-500R-SA	2K	Red	EB/SS, all tools
ISL38-500R-SR	2K	Red	EB/SS, rules based tools only

¹EasyBuilder/Spreadsheet

Components and accessories

CABLES		
	Product ID	Description
	CCB-84901-2001-XX	X-Coded Ethernet Cable, Straight (XX specifies length: 2m, 5m, 10m, 30m)
	CCB-84901-2002-XX	X-Coded Ethernet Cable, Right-Angled (XX specifies length: 2m, 5m, 10m)
	CCB-PWIO17-S-XX	M12 Power I/O cable with 17 pins to Flying Lead, Straight (XX specifies length: 2m, 5m, 10m, 20m)
	CCB-PWIO17-R-XX	M12 Power I/O cable with 17 pins to Flying Lead, Right Angle (XX specifies length: 2m, 5m, 10m, 20m)

CORRECTION TARGETS		
	Product ID	Description
	IS3D-CORR100-00	100 mm Correction Target
	IS3D-CORR40-00	40 mm Correction Target
	IS3D-CORR20-00	20 mm Correction Target
	IS3D-CORR10-00	10 mm Correction Target

IN-SIGHT L38 SERIES ENCODER		
	Product ID	Description
	LS-Encoder-1000-00	Incremental differential encoder 1000 ticks per revolution, RS422 output
	LS-Encoder-2500-00	Incremental differential encoder 2500 ticks per revolution, RS422 output
	LS-Encoder-5000-00	Incremental differential encoder 5000 ticks per revolution, RS422 output

For more information on encoders, please download the [In-Sight L38 Series Encoder](#) datasheet.

WORKING DISTANCE AND FIELD OF VIEW

	ISL38-33	ISL38-50	ISL38-100	ISL38-300	ISL38-500
Clearance distance (CD)	93 mm	92 mm	130 mm	180 mm	600 mm
Near field of view (FOV)	33 mm	55 mm	75 mm	95 mm	405 mm
Far field of view (FOV)	39 mm	90 mm	180 mm	460 mm	1082 mm
Measurement range (MR)	44 mm	106 mm	235 mm	745 mm	1100 mm

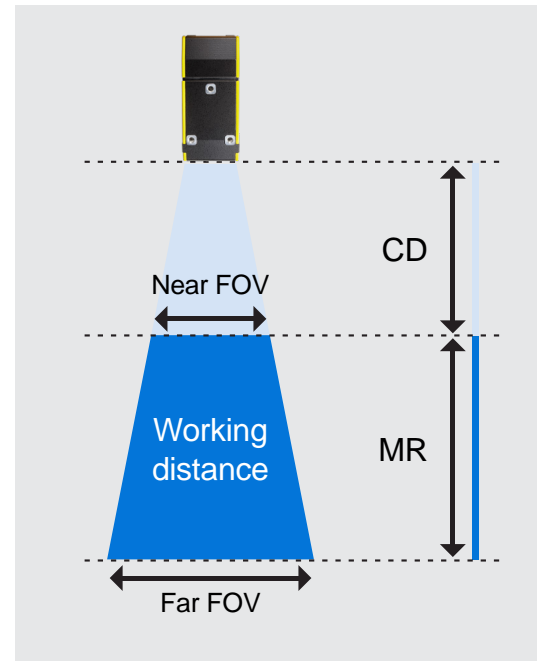

LENS TO LASER ANGLE (MEASURED AT THE CENTER OF FIELD OF VIEW)

	ISL38-33	ISL38-50	ISL38-100	ISL38-300	ISL38-500
Lens to Laser Angle	41.0°	34.6°	22.0°	10.3°	9.6°

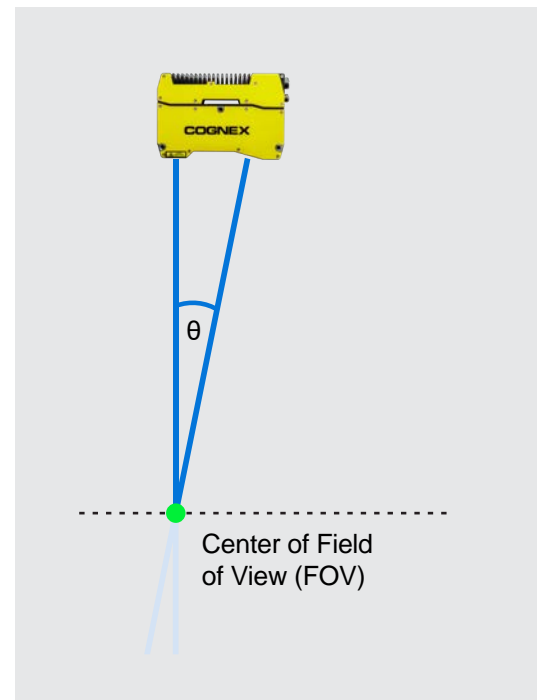

In-Sight L38

[Download CAD files](#)

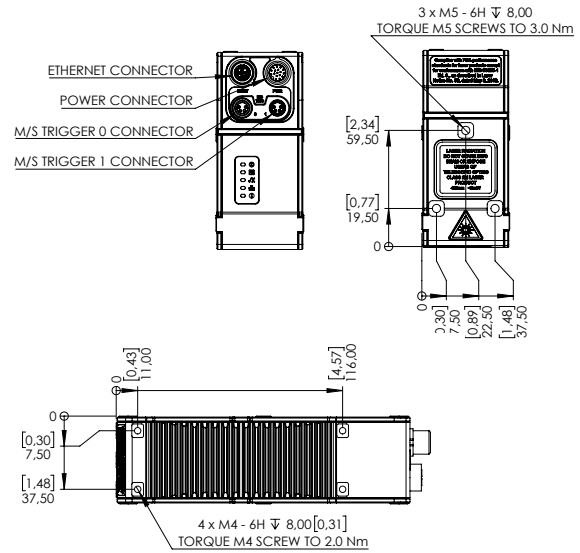
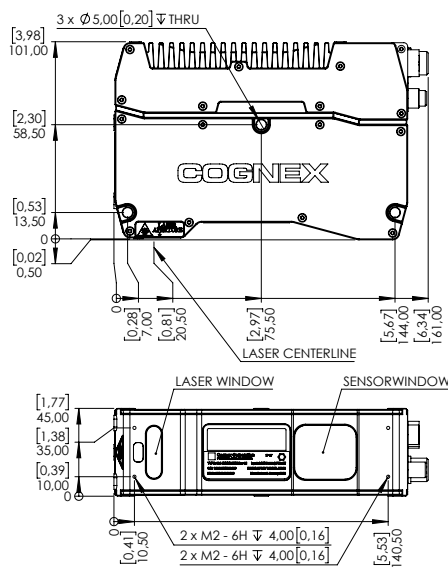

In-Sight L38-500

[Download CAD files](#)

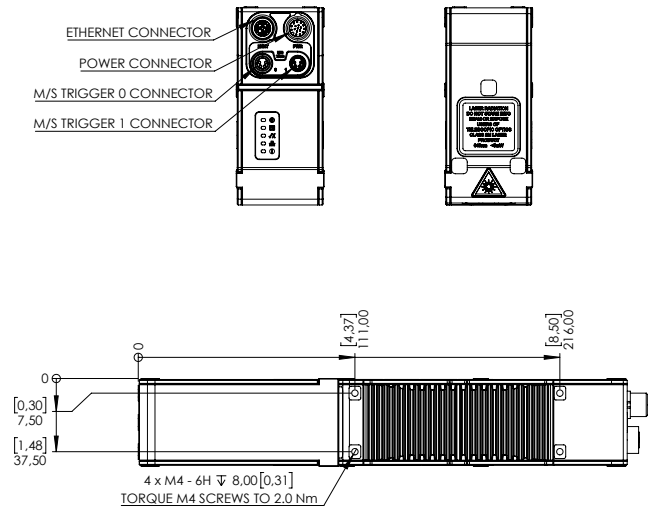
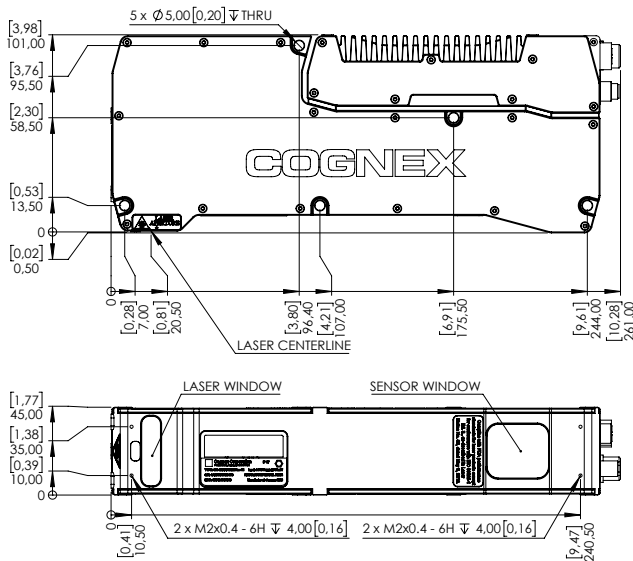

COGNEX

Companies around the world rely on Cognex vision and barcode reading solutions to optimize quality, drive down costs, and control traceability.

Corporate Headquarters One Vision Drive Natick, MA 01760 USA

Regional Sales Offices

Americas

North America +1 844 999 2469
Brazil +55 11 4210 3919
Mexico +800 733 4116

Europe

Austria +43 800 28 16 32
Belgium +32 289 370 75
Czechia +420 800 023 519
France +33 1 76 54 93 18
Germany +49 721 958 8052
Hungary +36 800 80291

Ireland +353 21 421 7500
Italy +39 02 3057 8196
Netherlands +31 207 941 398
Poland +48 717 121 086
Romania +40 741 041 272
Spain +34 93 299 28 14
Sweden +46 21 14 55 88
Switzerland +41 445 788 877
Turkey +90 216 900 1696
United Kingdom +44 121 29 65 163

Asia-Pacific

Australia +61 2 7202 6910
China +86 21 5875 1133

India +91 7305 040397
Indonesia +62 21 3076 1792
Japan +81 3 5977 5400
Korea +82 2 539 9047
Malaysia +6019 916 5532
New Zealand +64 9 802 0555
Philippines +63 2 8539 3990
Singapore +65 3158 3322
Taiwan +886 02 7703 2848
Thailand +66 6 3230 9998
Vietnam +84 98 2405167

© Copyright 2024, Cognex Corporation. All information in this document is subject to change without notice. All Rights Reserved. Cognex, In-Sight, and EasyBuilder are registered trademarks of Cognex Corporation. ViDi is a trademark of Cognex Corporation. All other trademarks are property of their respective owners.

Lit. No. L38DS-03-2024

www.cognex.com